

mini  
TEETUBE

TH391

IP68 5bar

CE

MADE IN ITALY

**TH391**  
Installazione a pannello  
Panel-mounting installation  
**2-3-4 POLES**

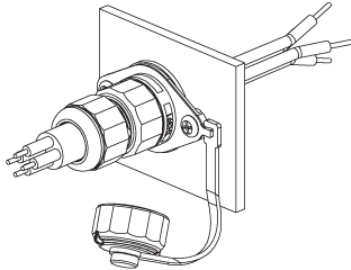

1

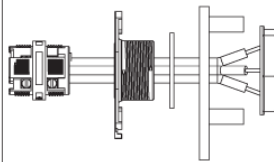

**Versione perforazione isolante**  
Piercing terminals version  
Code: THP.XXX.XXX



No sguainatura  
No unsheathing

**Versione a vite standard**  
Screw terminals  
Code: THB.XXX.XXX (THR.XXX.XXX)

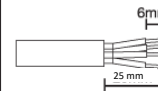

2

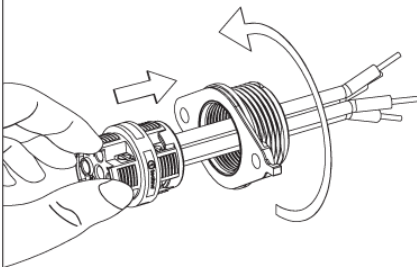

3

3.a

**Fissaggio con viti**  
Fixing with screw

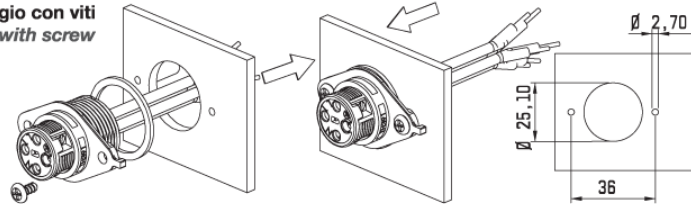

3.b

**Fissaggio con dado**  
Fixing with nut

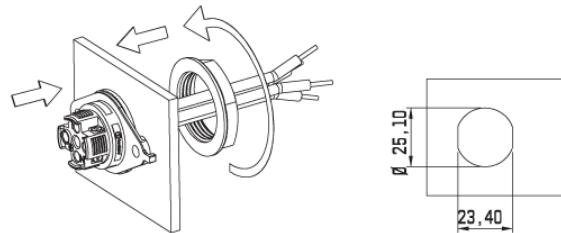

4

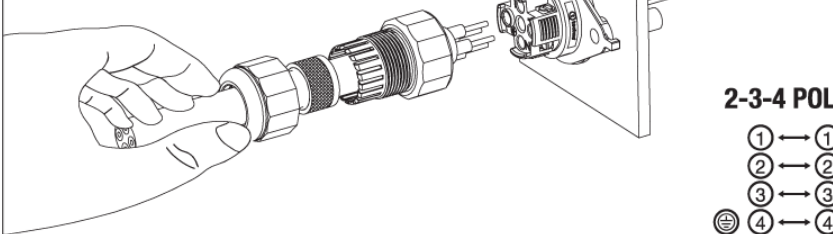
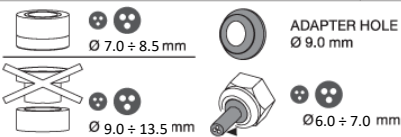

**2-3-4 POLES**

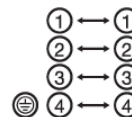

**Versione perforazione isolante**  
Piercing terminals version  
Code: THP.XXX.XXX

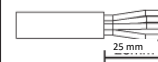

No sguainatura  
No unsheathing

**Versione a vite standard**  
Screw terminals  
Code: THB.XXX.XXX (THR.XXX.XXX)

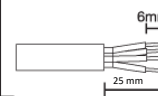

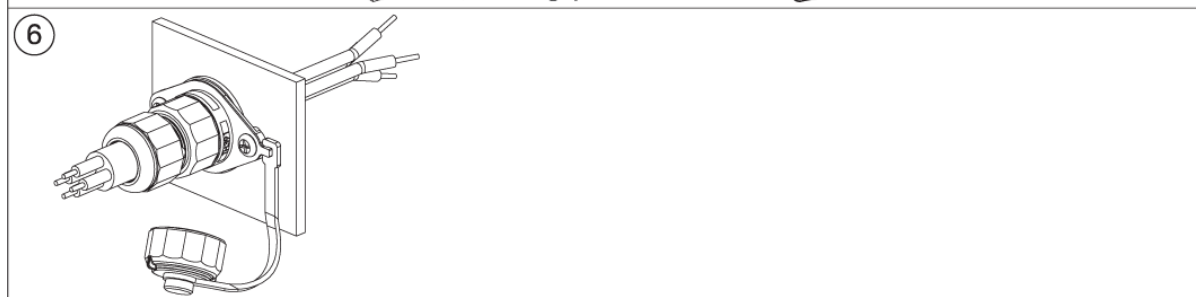
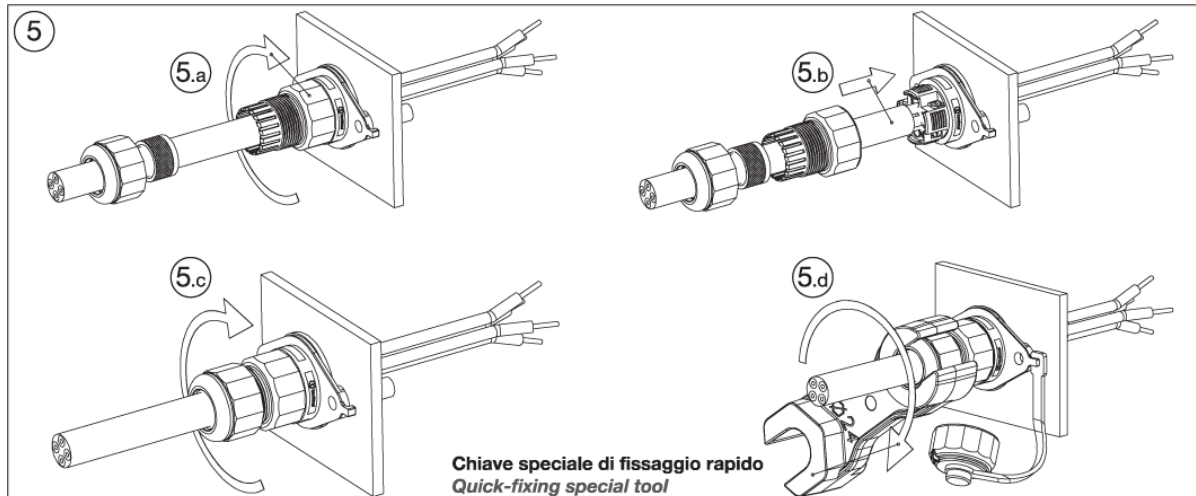

**TH391**  
**2-3-4 POLES**

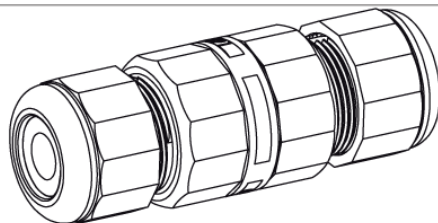

**Versione lineare**  
*In-line connector version*

Visit us on [www.techno.it](http://www.techno.it)

**Accessori su richiesta**  
*Accessories on request*

**Importante:** I connettori TEEfamily<sup>®</sup> sono omologati con grado di protezione IP68 (immersione continua) senza l'utilizzo di gel e resine. Conferiscono i seguenti vantaggi:

- Utilizzabili sotto terra
- Rapidità e affidabilità nel cablaggio
- Utilizzo di materiali atossici (REACH, RoHS)
- Connessioni ri-ispezionabili
- Unico codice di acquisto

**Important:** TEEfamily<sup>®</sup> connectors are IP68 certified (continuous immersion in water) for use without gel and resin. They give users the following benefits:

- Can be used underground
- Fast and reliable wiring
- Use of non-toxic materials (REACH, RoHS)
- Connections can be re-inspected
- One purchasing code



**IP68**

**50m**  
**5bar**

Omologato e certificato secondo EN60998.  
*Approved and certified in accordance with EN60998.*

