

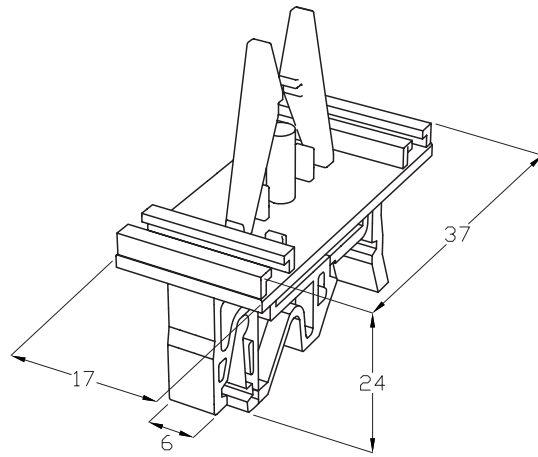

TH350

PATENTED

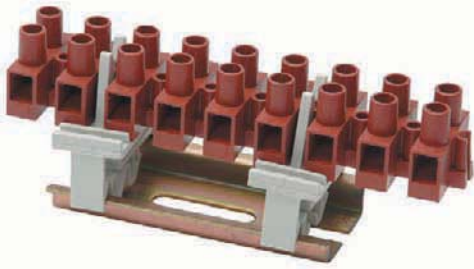

Supporto morsettiera universale per barre DIN.
Passo 8-10-12.
Grande flessibilità di impiego.

*DIN support for terminal blocks pitch 8-10-12.
For an easy and highly flexible installation.
Strong and easily assembling.*

Dati tecnici - Technical data

Dimensioni facilmente adattabili.
Easily adaptable dimensions.

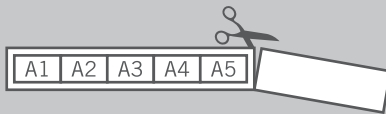

Codice - Part number

T H A . 3 5 0 . A 1 A



G-32 EN 50035 - DIN 46277/1



H-35 EN 50022 - DIN 46277/3

Materie prime - Raw materials

Materia plastica - Plastics

PA66 UL94 V2 GWT 850°C **-20°C**
Grigio - Grey RAL 7035 **+125°C**

Accessori - Accessories



Supporto per etichette.
Wiring circuits numbers holder.

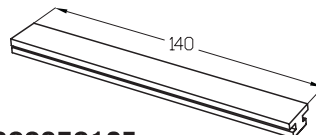

6003501CE

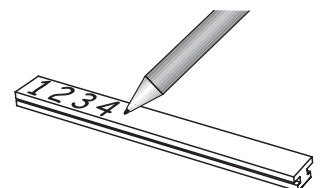

Norme - Standards



*Eventuali modifiche e migliorie sui dati tecnici o sul prodotto potranno essere effettuate senza preavviso.
All technical data or other eventual product modifications and improvements can be carried out without notice*

Kit di fornitura non assemblato THA
Unassembled kit THA

THA.350.XXX

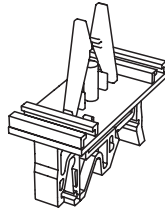
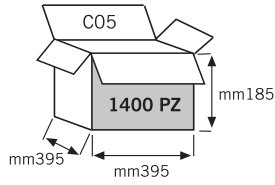

1400 PZ

Kit di fornitura con versionamenti e confezionamenti speciali THK
Special custom packed version THK

THK.350.XXX

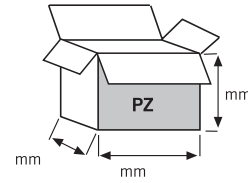

Kit di fornitura imbustati THR
Fare riferimento a catalogo THR
Retail packed kit THR
Please refer to THR Retail Catalogue

THR.350.SXX

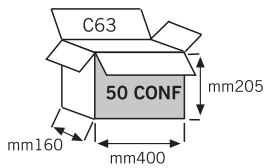

1 CONF
 10 PZ

